



## EC-Type Examination Certificate

- (1)  
(2) **Equipment or Protective Systems Intended for use  
in Potentially Explosive Atmospheres  
Directive 94/9/EC**

(3) EC-Type Examination Certificate Number:

**FTZÚ 04 ATEX 0143X**

- (4) Equipment or protective system: **Flameproof fluorescent luminaire type PITBUL-Ex**
- (5) Manufacturer: **Ing. L. Vyrtych – Elektrotechnický závod**
- (6) Address: **294 06 Březno 114, Czech Republic**
- (7) This equipment or protective system and any of acceptable variation thereto is specified in the schedule to this certificate and the documents therein referred to.
- (8) The Physical Technical Testing Institute, notified body number 1026 in accordance with Article 9 of the Council Directive 94/9/EC of 23 March 1994, certifies that this equipment or protective system has been found to comply with the Essential Health and Safety Requirements relating to the design and construction of equipment and protective systems intended for use in potentially explosive atmospheres given in Annex II to the Directive.

The examination and test results are recorded in confidential Report N°

**04/0143 dated 27 September 2004**

- (9) Compliance with Essential Health and safety requirements has been assured by compliance with:  
**EN 50014:+A1:+A2:1997; EN 50018:2000; EN 50019:2000;  
EN 50028:1994; EN 50281-1-1:1998**
- (10) If the sign „X“ is placed after the certificate number, it indicates that the equipment or protective system is subject to special conditions for safe use specified in the schedule to this certificate.
- (11) This EC-TYPE EXAMINATION CERTIFICATE relates only to the design and construction of the specified equipment or protective system. If applicable, further requirements of this Directive apply to the manufacturer and supply of this equipment or protective system.
- (12) The marking of the equipment or protective system shall include following:

 **II 2GD EEx edm IIC T5 T 60°C** – with off-load switch  
 **II 2GD EEx em II T5 T 60°C** – without off-load switch

This EC-Type Examination Certificate is valid till: **30.09.2009**

Responsible person:

  
**Mr. Jaroslav Šindler**  
Head of certification body



Date of issue: 25.10.2004

Number of pages: 1/3

This certificate is granted subject to the general conditions of the Physical Technical Testing Institute.  
This certificate may only be reproduced in its entirety and without any change, schedule included.



Physical Technical Testing Institute  
Ostrava-Radvanice

(13)

Schedule

(14) **EC-Type Examination Certificate N° FTZÚ 04 ATEX 0143X**

(15) Description of Equipment or Protective System:

A type PITBUL-Ex fluorescent luminaire with degree of protection IP 65 is composed of two parts of the enclosure comprises a body manufactured from varnished steel plate or stainless steel plate of the thickness 1mm, and the light transmitting cover made from safety toughened glass of the thickness 5mm, which are mutually fixated through EPDM gasket by sealed steel screws. On the opposite sides of the body are holes to accept OBO V-TEC M20x1,5 or M25x1,5; IP 68 cable glands (resp. cable plug) at design EEx e II (PTB 99 ATEX 3112X), at the stainless version are used PFITSCH M20x1,5 or M25x1,5; IP 68 cable glands (resp. plug) at design EEx e II (PTB 98 ATEX 3109). Inside of the enclosure is on the varnished steel plate reflector installed three-pole (or five-pole) terminal block WAGO type 262-283, (262-285) or 262-233, (262-235) at design EEx e II (PTB 98 ATEX 3125U) for connection of the cable conductors to 4mm<sup>2</sup>, couple of lampholders BAREL type 96Xb (NEMKO 02 ATEX 329U) at design EEx e II, in compliance with used number of the lamps, one or two electronic ballast BAREL type HFX... (NEMKO 03 ATEX 204U) at design EEx me II T5, and with or without off-load switch BARTEC type 07-1544 (PTB 99 ATEX 1011U) at design EEx d IIC, by the type of luminaire. As the light sources are used Bi-pin fluorescent lamps type T26/G13 2;3;4 x 18W; 2;3;4 x 36W or 2;3;4 x 58W for nominal voltage 230V/50-60Hz, 230 V DC.

(16) Report No. : 04/0143

27.09.2004

(17) Special conditions for safe use:

The type luminaire without installed off-load switch must be labelled "Do not open when energized".

(18) Essential Health and Safety Requirements:

Covered by standards mentioned in (9).

Responsible person:

**Mr. Jaroslav Šindler**

Head of certification body



Date of issue: 25.10.2004

Number of pages: 2/3

This certificate is granted subject to the general conditions of the Physical Technical Testing Institute.  
This certificate may only be reproduced in its entirety and without any change, schedule included.



Physical Technical Testing Institute  
Ostrava-Radvanice

(13)

**Schedule**

(14) **EC-Type Examination Certificate N° FTZÚ 04 ATEX 0143X**

(19)

**LIST OF DOCUMENTATION**

➤ Drawings No.:	3803-0-06-1	03.05.2004	
	3481-0-06-9	03.05.2004	
	3481-0-06-8	03.05.2004	
	3481-0-06-7	03.05.2004	
	3481-0-14-2	28.03.2004	
	3481-5-98-1	03.05.2004	
	3481-5-59-2	03.05.2004	
	3481-0-14-1	26.02.2004	
➤ Technical description No.:	PITBUL-Ex	03.05.2004	11 pages
➤ User manual:	PITBUL-Ex		2 pages
➤ Certificates No.:	Nemko 02 ATEX 329U	01.04.2003	lampholder G13
	PTB 99 ATEX 1011U	15.04.1999	off-load switch
	Nemko 03 ATEX 204U	13.05.2003	electronic ballast
	PTB 98 ATEX 3125U	09.10.1998	terminal block
	PTB 99 ATEX 3112X	10.11.1999	cable glands
	PTB 98 ATEX 3109	17.04.1998	cable glands

(20)

**MARKING OF LUMINAIRE DESIGN**

**PITBUL – Ex – xxx – y – xx**

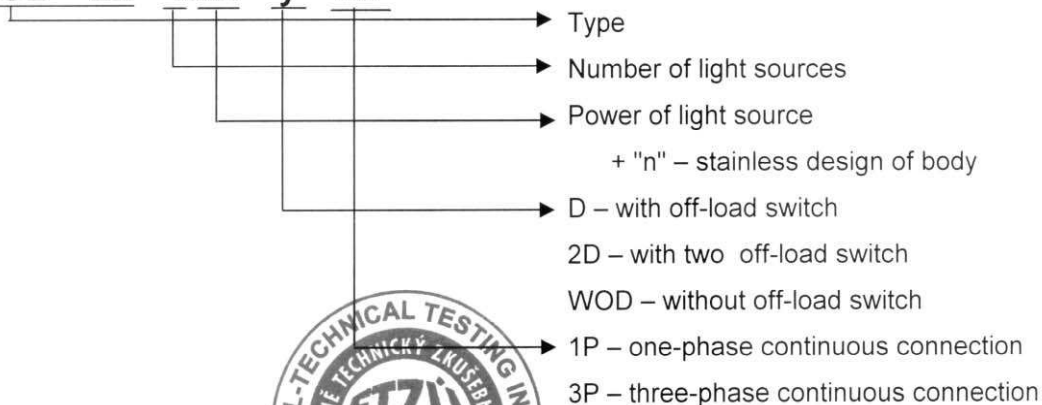



(1) **Supplement No. 1 to  
EC-Type Examination Certificate**

(2) **Equipment or Protective Systems Intended for use  
in Potentially Explosive Atmospheres  
Directive 94/9/EC**

(3) EC-Type Examination Certificate Number:

**FTZÚ 04 ATEX 0143X**

(4) Equipment or protective system: **Flameproof fluorescent luminaire type PITBUL-Ex**

(5) Manufacturer: **Ing. L. Vyrtych – Elektrotechnický závod**

(6) Address: **294 06 Březno 114, Czech Republic**

(7) This supplement of certificate is valid for: - modification of certified apparatus

(8) Modification of certified apparatus (protective system) and any of its approved variants are specified in documentation, list of which is mentioned in schedule of this certificate.

(9) This supplement to type examination certificate is valid only for type examination of design and construction of product sample in accordance with Annex 3 Paragraph 6) of Directive No. 94/9/EC. The Directive contains another requirement, which manufacturer shall fulfil before products are placed on market or introduced in service.

(10) Safety requirements of modified parts were fulfilled by satisfying the following standards:

**EN 50014:1997+A1+A2**

**EN 50018:2000**

**EN 50019:2000**

**EN 50028:1994**

**EN 50281-1-1:1998**

**EN 50017:1998**

(11) Marking of equipment shall contain symbols:

 **II 2GD EEx qed IIC T5 T 60°C** – with off-load switch

 **II 2GD EEx qed IIC T5 T 60°C** – without off-load switch

(12) This type examination certificate is valid till: **31.08.2009**

Responsible person:

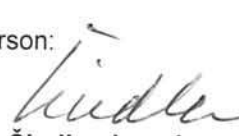
  
**Dipl. Ing. Šindler Jaroslav**

Head of certification body



Date of issue: 10.06.2005

Number of pages: 2

Page: 1/2

This supplement to certificate is granted subject to the general conditions of the Physical Technical Testing Institute.  
This supplement to certificate may only be reproduced in its entirety and without any change, schedule included.



**Physical Technical Testing Institute  
Ostrava-Radvanice**

(13) **Schedule**

(14) **Supplement No. 1 to  
EC-Type Examination Certificate N° FTZÚ 04 ATEX 0143X**

(15) Description of Equipment or Protective System:

A type PITBUL-Ex luminaire was modified for use by other new components installed inside of luminaire - electronic ballasts: TRIDONIC, type PCX\*x\*\*E101 (PTB 01 ATEX 1048U) at protection mode EEx qe II T5, and CEAG, type EVG 97... and type EVG 05... (PTB 98 ATEX 1086U and PTB 05 ATEX 2018U) at protection mode EEx ed IIC, and for connecting cables there were used cable glands resp. plugs at protection mode EEx e II: PFLITSCH, type U59.UNI Dicht, M 20x1,5 or M 25x1,5; IP68 (PTB 02 ATEX 1115X), and type U28.UNI, M 20x1,5 or M 25x1,5; IP68 (PTB 01 ATEX 3104X).

(16) Report No. : 04/0143-d1 09.06.2005

(17) Special conditions for safe use:

The type luminaire without installed off-load switch must be labelled "Do not open when energized".

(18) Essential Health and Safety Requirements:

Covered by standards mentioned in (10) of this supplement.

(19) LIST OF DOCUMENTATION

➤	Technical description	01.03.05	
➤	Drawings No.	3481-5-98-1_1	03.05.04 Rev. 04.03.05
		3481-5-98-1_2	03.05.04 Rev. 04.03.05
➤	Certificate No.	PTB 01 ATEX 1048U	12.06.01
		PTB 98 ATEX 1086U	16.03.99
		PTB 05 ATEX 2018U	11.03.05
		PTB 02 ATEX 1115X	17.10.02
		PTB 98 ATEX 3109	17.04.98

Responsible person:

**Dipl. Ing. Šindler Jaroslav**  
Head of certification body



Date of issue: 10.06.2005

Number of pages: 2

Page: 2/2

This supplement to certificate is granted subject to the general conditions of the Physical Technical Testing Institute.  
This supplement to certificate may only be reproduced in its entirety and without any change, schedule included.



Physical Technical Testing Institute  
Ostrava-Radvanice



(1) **Supplement No. 2 to  
EC-Type Examination Certificate**

(2) **Equipment or Protective Systems Intended for use  
in Potentially Explosive Atmospheres  
Directive 94/9/EC**

(3) EC-Type Examination Certificate Number:

**FTZÚ 04 ATEX 0143X**

(4) Equipment or protective system: **Flameproof fluorescent luminaire type PITBUL-Ex**

(5) Manufacturer: **Ing. L. Vyrtych – Elektrotechnický závod**

(6) Address: **294 06 Březno 114, Czech Republic**

(7) This supplement of certificate is valid for: - modification of certified apparatus

(8) Modification of certified apparatus (protective system) and any of its approved variants are specified in documentation, list of which is mentioned in schedule of this certificate.

(9) This supplement to type examination certificate is valid only for type examination of design and construction of product sample in accordance with Annex 3 Paragraph 6) of Directive No. 94/9/EC. The Directive contains another requirement, which manufacturer shall fulfil before products are place on market or introduce in service.

(10) Safety requirements of modified parts were fulfilled by satisfying the following standards:

**EN 50014:1997+A1+A2**

**EN 50018:2000**

**EN 50019:2000**

**EN 50028:1994**

**EN 50281-1-1:1998**

**EN 50017:1998**

(11) Marking of equipment shall contain symbols:

 **II 2GD EEx qmed IIC T5 T 60°C** – with off-load switch

 **II 2GD EEx qmed IIC T5 T 60°C** – without off-load switch

(12) This type examination certificate is valid till: **30.09.2009**

Responsible person:

  
**Dipl. Ing. Sindler Jaroslav**

Head of certification body



Date of issue: 20.02.2006

Number of pages: 2

Page: 1/2

This supplement to certificate is granted subject to the general conditions of the Physical Technical Testing Institute.  
This supplement to certificate may only be reproduced in its entirety and without any change, schedule included.





**Physical Technical Testing Institute  
Ostrava-Radvanice**

(13)

**Schedule**

(14)

**Supplement No. 2 to  
EC-Type Examination Certificate No. FTZÚ 04 ATEX 0143X**

(15) Description of Equipment or Protective System:

A type PITBUL-Ex luminaire was modified for use by the other new components installed in luminaire. That is concerned of the cable glands resp. plugs (polyamide) type GHG 960 92..., IP 66 (PTB 99 ATEX 3128X) at type of protection  $\text{Ex}$  II 2GD EEx e II, and dummy plugs (polyamide) type GHG 960 663.P..., IP 66 (PTB 98 ATEX 3130) at type of protection  $\text{Ex}$  II 2G EEx e II. For discharging condensation water from enclosure of luminaire may be used drain plug type GHG 960 1972 R...; M25x1,5; IP 54 (PTB 01 ATEX 1128X) at type of protection  $\text{Ex}$  II 2G EEx e II. When the drain plug is used than the final type of protection of the luminaire is IP 54.

(16) Report No.: 04/0143-d2 16.02.2006

(17) Special conditions for safe use:

The type luminaire without installed off-load switch must be labelled "Do not open when energized".

(18) Essential Health and Safety Requirements:

Covered by standards mentioned in (10) of this supplement.

(19) LIST OF DOCUMENTATION

➤	Technical description	PITBUL-Ex – modification 02	25.11.2005	
➤	Drawings No.	GHG 96 – 3 – 3983	22.10.1996	
		GHG 96 – 3 – 3763	19.12.1991	
		GHG 96 – 4 – 3975	22.07.1997	
		GHG 960 – 3 – 3989	18.11.1997	
		GHG 96 – 4 – 3301	10.10.2001	
➤	Certificates No.	PTB 01 ATEX 1128X	13.11.2001	
		PTB 98 ATEX 3130	12.11.1998	+ supplement No. 1
		PTB 99 ATEX 3128X	20.11.1998	+ supplements No. 1 ÷ 4

Responsible person:

  
**Dipl. Ing. Šindler Jaroslav**  
Head of certification body



Date of issue: 20.02.2006

Number of pages: 2  
Page: 2/2

This supplement to certificate is granted subject to the general conditions of the Physical Technical Testing Institute.  
This supplement to certificate may only be reproduced in its entirety and without any change, schedule included.



(1) **Supplement No. 3 to  
EC-Type Examination Certificate**

(2) **Equipment or Protective Systems Intended for use  
in Potentially Explosive Atmospheres  
Directive 94/9/EC**

(3) EC-Type Examination Certificate Number:

**FTZÚ 04 ATEX 0143X**

(4) Equipment or protective system: **Flameproof luminaire type PITBUL-Ex**

(5) Manufacturer: **VYRTYCH a.s.**

(6) Address: **Židněves 116, 294 06 Březno, Czech Republic**

(7) This supplement of certificate is valid for:

- Modification of certified apparatus
- Verification according to new standards
- Prolongation of certificate validity
- Change of the name and address of the producer

(8) Modification of certified apparatus (protective system) and any of its approved variants are specified in documentation, list of which is mentioned in schedule of this certificate.

(9) This supplement to type examination certificate is valid only for type examination of design and construction of product sample in accordance with Annex 3 Paragraph 6) of Directive No. 94/9/EC. The Directive contains another requirement, which manufacturer shall fulfil before products are placed on market or introduced in service.

(10) Safety requirements of modified parts were fulfilled by satisfying the following standards:

**EN 60079-0:2006; EN 60079-1:2004; EN 60079-7:2006; EN 50017:1998  
EN 60079-18:2004; EN 61241-0:2006; EN 61241-1:2004**

(11) Marking of equipment shall contain symbols:

**Ex II 2GD Ex deq mb tD A IIC T5 T60°C** – with off-load switch

**Ex II 2GD Ex deq mb tD A IIC T5 T60°C** – without off-load switch

(12) This type examination certificate is valid till: **28.02.2013**

Responsible person:  
  
Dipl. Ing. Jaroslav Šindler  
Head of certification body

Date of issue: 11.02.2008

Number of pages: 3  
Page: 1/3

This supplement to certificate is granted subject to the general conditions of the Physical Technical Testing Institute.  
This supplement to certificate may only be reproduced in its entirety and without any change, schedule included.





Physical Technical Testing Institute  
Ostrava-Radvanice

(13)

Schedule

(14)

Supplement No. 3 to  
EC-Type Examination Certificate N° FTZÚ 04 ATEX 0143X

(15) Description of Equipment or Protective System:

- 1) A type PITBUL-Ex flameproof fluorescent luminaire was modified for use of electronic ballasts made by firm BAREL type HFX (IECEX NEM 07 0003U II 2G Ex mbe II T5), and firm JAKUBIEC type ESJ2/ESJ4 (FTZÚ 04ATEX0145U II 2G Ex e mb II).
- 2) The types PITBUL-Ex luminaires are recertified according to standards EN 60079-0:2006; EN 60079-1:2004; EN 60079-7:2006; EN 50017:1998; EN 60079-18:2004; EN 61241-1:2004 and EN 61241-0:2006. There on the apparatus are not made any constructional changes in comparison to the certified model.
- 3) At the producer was made change of the name and address from Ing. L. Vyrtych – Elektrotechnický závod, 294 06 Březno 114 to VYRTYCH a.s., Židněves 116, 294 06 Březno, Czech Republic.

**Basic technical data:**

Type: PITBUL-Ex  
Rated voltage: 220-250V / 50-60Hz, 220-250V / 0 Hz – acc. to used ballast  
Light sources: linear fluorescent lamp T26/G13 1;2;3;4 x 18W; 36W; 58W  
Ambient temperature: -20°C to +40°C  
Degree of protection: IP 65

**Design:**

<b>With electronic ballast of the producer BAREL and JAKUBIEC</b>	
<i>with off-load switch</i>	<i>without off-load switch</i>
II 2GD Ex de mb tD A IIC T5 T60°C	II 2GD Ex e mb tD A II T5 T60°C
<b>With electronic ballast of the producer TRIDONIC</b>	
II 2GD Ex deq tD A IIC T5 T60°C	II 2GD Ex eq tD A II T5 T60°C
<b>With electronic ballast of the producer CEAG</b>	
II 2GD Ex de tD A IIC T5 T60°C	II 2GD Ex de tD A IIC T5 T60°C

Responsible person:

Date of issue: 11.02.2008

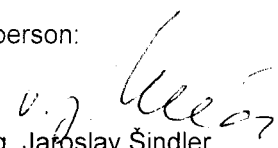
  
Dipl. Ing. Jaroslav Šindler  
Head of certification body

Page: 2/3

This supplement to certificate is granted subject to the general conditions of the Physical Technical Testing Institute.  
This supplement to certificate may only be reproduced in its entirety and without any change, schedule included.



**Physical Technical Testing Institute  
Ostrava-Radvanice**

(13) **Schedule**

(14) **Supplement No. 3 to  
EC-Type Examination Certificate N° FTZÚ 04 ATEX 0143X**

(16) Report No. : 04/0143-d3 06.02.2008

(17) Special conditions for safe use:

The type luminaire without installed off-load switch must be labelled "Do not open when energized".

(18) Essential Health and Safety Requirements:

Covered by standards mentioned in (10) of this supplement.

(19) LIST OF DOCUMENTATION:

➤ Technical description	PITBUL-Ex, 9 pages	05.12.2007	
➤ Technical conditions	PITBUL-Ex, 2 pages	05.12.2007	
➤ Drawings No.	3481-5-98-1_1	03.05.2004	rev. 05.12.2007
	3481-5-98-1_2	03.05.2004	rev. 05.12.2007
➤ Plates.		05.12.2007	

Responsible person:

Date of issue: 11.02.2008

  
Dipl. Ing. Jaroslav Šindler  
Head of certification body

Page: 3/3

This supplement to certificate is granted subject to the general conditions of the Physical Technical Testing Institute.  
This supplement to certificate may only be reproduced in its entirety and without any change, schedule included.



(1) **Supplement No. 4 to  
EC-Type Examination Certificate**

(2) **Equipment or Protective Systems Intended for use  
in Potentially Explosive Atmospheres  
Directive 94/9/EC**

(3) EC-Type Examination Certificate Number:

**FTZÚ 04 ATEX 0143X**

(4) Equipment or protective system: **Flameproof luminaire type PITBUL-Ex**

(5) Manufacturer: **VYRTYCH a.s.**

(6) Address: **Bělehradská 314/18, 140 00 Praha 4, Czech Republic**

(7) This supplement of certificate is valid for: - Modification of certified apparatus  
- Change of address of the producer

(8) Modification of certified apparatus (protective system) and any of its approved variants are specified in documentation, list of which is mentioned in schedule of this certificate.

(9) This supplement to type examination certificate is valid only for type examination of design and construction of product sample in accordance with Annex 3 Paragraph 6) of Directive No. 94/9/EC. The Directive contains another requirement, which manufacturer shall fulfil before products are placed on market or introduced in service.

(10) Safety requirements of modified parts were fulfilled by satisfying the following standards:

**EN 60079-0:2006; EN 60079-1:2007; EN 60079-7:2006;**

**EN 60079-18:2004; EN 61241-0:2006; EN 61241-1:2004**

(11) Marking of equipment shall contain symbols:

 **II 2GD Ex d e mb tD A IIC T5 T60°C**

(12) This type examination certificate is valid till: **31.05.2012**

Responsible person:

  
Dipl. Ing. Jaroslav Šindler  
Head of certification body



Date of issue: 07.11.2011

Number of pages: 2  
Page: 1/2



**Physical Technical Testing Institute  
Ostrava-Radvanice**

**Schedule**

(13)

(14)

**Supplement No. 4 to  
EC-Type Examination Certificate N° FTZÚ 04 ATEX 0143X**

(15) Description of Equipment or Protective System:

- 1) A type PITBUL-Ex flameproof fluorescent luminaire was modified for use of modified lampholders type VOB-Ex manufactured by VYRTYCH a.s., in type of Ex-protection  $\text{Ex II 2G Ex e II Gb}$  (FTZÚ 10 ATEX 0178U/1) and off-load switch type VOD-Ex manufactured by VYRTYCH a.s., in type of Ex-protection  $\text{Ex II 2G Ex d IIC Gb}$  (FTZÚ 10 ATEX 0297U).
- 2) At the producer was made change of adress from Židněves 116, 294 06 Březno to Bělehradská 314/18, 140 00 Praha 4, Czech Republic.

Equipment parameters are without any changes.

Mentioned changes have no influence on design and safety of the equipment.

**Design:**

<b>With electronic ballast of the producer BAREL and JAKUBIEC</b>	
<i>with off-load switch</i>	<i>without off-load switch</i>
II 2GD Ex d e mb tD A IIC T5 T60°C	II 2GD Ex e mb tD A II T5 T60°C
<b>With electronic ballast of the producer CEAG</b>	
II 2GD Ex d e tD A IIC T5 T60°C	II 2GD Ex d e tD A IIC T5 T60°C

(16) Report No. : 04/0143-d4

06.10.2011

(17) Special conditions for safe use:

The type luminaire without installed off-load switch must be labelled "Do not open when energized".

(18) Essential Health and Safety Requirements:

Covered by standards mentioned in (10) of this supplement.

(19) LIST OF DOCUMENTATION:

- Technical description 6/2011 Mod.06
- Certificates No: FTZÚ 10 ATEX 0178U/1 4/2011 Lampholder type VOB-Ex
- FTZÚ 10 ATEX 0297U 12/2010 Off-load switch type VOD-Ex

Responsible person:

Dipl. Ing. Jarošlav Šindler  
Head of certification body

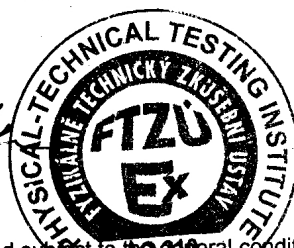

Date of issue: 07.10.2011

Page: 2/2

This supplement to certificate is granted subject to the general conditions of the Physical Technical Testing Institute.  
This supplement to certificate may only be reproduced in its entirety and without any change, schedule included.



(1) **Supplement No. 5 to  
EC-Type Examination Certificate**

(2) **Equipment or Protective Systems Intended for use  
in Potentially Explosive Atmospheres  
Directive 94/9/EC**

(3) EC-Type Examination Certificate Number:

**FTZÚ 04 ATEX 0143X**

(4) Equipment or protective system: **Flameproof luminaire type  
PITBUL-Ex, PITBUL -Ex-Em, MULTIPITBUL-Ex**

(5) Manufacturer: **VYRTYCH a.s.**

(6) Address: **Bělehradská 314/18, 140 00 Praha 4, Czech Republic**

(7) This supplement of certificate is valid for: - Modification of certified apparatus  
- Verification according to new standards  
- Prolongation of certificate validity

(8) Modification of certified apparatus (protective system) and any of its approved variants are specified in documentation, list of which is mentioned in schedule of this certificate.

(9) This supplement to type examination certificate is valid only for type examination of design and construction of product sample in accordance with Annex 3 Paragraph 6) of Directive No. 94/9/EC. The Directive contains another requirement, which manufacturer shall fulfil before products are place on market or introduce in service.

(10) Safety requirements of modified parts were fulfilled by satisfying the following standards:

**EN 60079- 0:2009; EN 60079-1:2007; EN 60079-7:2007;**

**EN 60079-11:2007; EN 60079-18:2004; EN 60079-31:2009**

(11) Marking of equipment shall contain symbols:

 **II 2G Ex d e ib mb IIC T4 Gb**

 **II 2D Ex t IIIC Db T 60°C**

(12) This type examination certificate is valid till: **31.07.2017**

Responsible person:

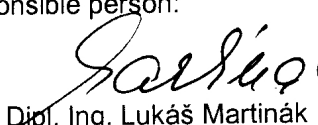
  
Dipl. Ing. Lukáš Martinák  
Head of certification body

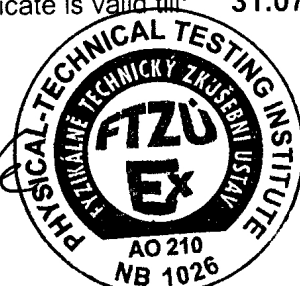

Date of issue: **30.07.2012**

Number of pages: 3  
Page: 1/3

This supplement to certificate is granted subject to the general conditions of the Physical Technical Testing Institute.  
This supplement to certificate may only be reproduced in its entirety and without any change, schedule included.



Physical Technical Testing Institute  
Ostrava-Radvanice

(13)

Schedule

(14)

Supplement No. 5 to  
EC-Type Examination Certificate N° FTZÚ 04 ATEX 0143X

(15) Description of Equipment or Protective System:

- 1) A type PITBUL-Ex, PITBUL-Ex-Em, MULTIPITBUL-Ex flameproof fluorescent luminaire was modified for use electronic ballasts type HFX manufactured by BAREL and EVG 09xxx manufactured by CEAG only, use electronic module of emergency lighting type HFxE manufactured by BAREL in Ex-protection II 2G Ex e mb II T5 (Nemko 09 ATEX 1103U) or type MAz 5... manufactured by JAKUBIEC in Ex-protection II 2G Ex e mb II (FTZÚ 04 ATEX 0146U), use battery set for emergency luminaires type Jd2 and Jd3 manufactured by JAKUBIEC in Ex-protection II 2G Ex d IIC T6 (FTZÚ 05 ATEX 0286X) or type VBA-Ex manufactured by VYRTYCH in Ex-protection II 2G Ex mb II T5 (FTZÚ 10 ATEX 0145X) and in possibility luminaire equipment by Watchdog module type CG-S manufactured by CEAG in Ex-protection II 2G Ex e ib mb IIC (PTB 04 ATEX 2110U).
- 2) The luminaires are recertified according to standards EN 60079-0:2009; EN 60079-1:2007; EN 60079-7:2007; EN 60079-11:2007; EN 60079-18:2004 and EN 60079-31:2009.

Equipment parameters are without any changes.

There on the apparatus are not made any constructional changes in comparison to the certified model.

(16) Report No. : 04/0143-d5

27.07.2012

(17) Special conditions for safe use:

17.1 The type luminaire without installed off-load switch must be labelled "Do not open when energized".

17.2 Ambient temperature for type PITBUL-Ex-Em a MULTIPITBUL-Ex luminaires: Ta: 0°C to +40°C

(18) Essential Health and Safety Requirements:

Covered by standards mentioned in (10) of this supplement.

(19) LIST OF DOCUMENTATION:

- Technical description 7/2012 Mod.07
- Instructions for mounting 7/2012
- Certificates No: BVS 09 ATEX E 054U Electronic Ballast type EVG 09...  
Nemko 09 ATEX 1103U Electronic module of emergency lighting type HFxE  
FTZÚ 04 ATEX 0146U Electronic module of emergency lighting type MAz 5....  
FTZÚ 05 ATEX 0286X Battery set type Jd2, Jd3  
FTZÚ 10 ATEX 0145X Battery set type VBA-Ex-....  
PTB 04 ATEX 2110U Watchdog module type CG-S

Responsible person:

  
Dipl. Ing. Lukáš Martinák  
Head of certification body



Date of issue: 30.07.2012

Page: 2/3

This supplement to certificate is granted subject to the general conditions of the Physical Technical Testing Institute.  
This supplement to certificate may only be reproduced in its entirety and without any change, schedule included.



**Physical Technical Testing Institute  
Ostrava-Radvanice**

(13)

**Schedule**

(14)

**Supplement No. 5 to  
EC-Type Examination Certificate N° FTZÚ 04 ATEX 0143X**

(20) MARKING OF LUMINAIRE DESIGN

**PITBUL – Ex – xxx – y – xx**

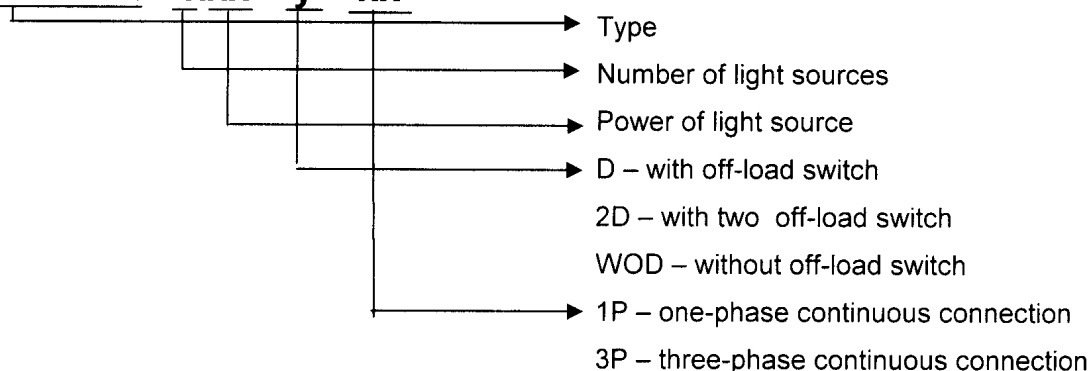

**PITBUL – Ex – Em – xxx – xx**

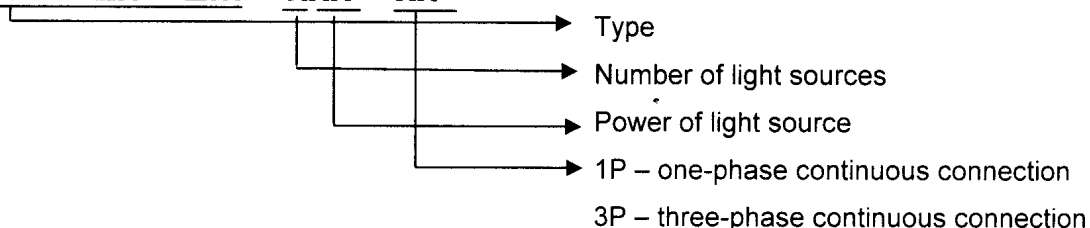

**MULTIPITBUL – Ex – xxx – y – xx**

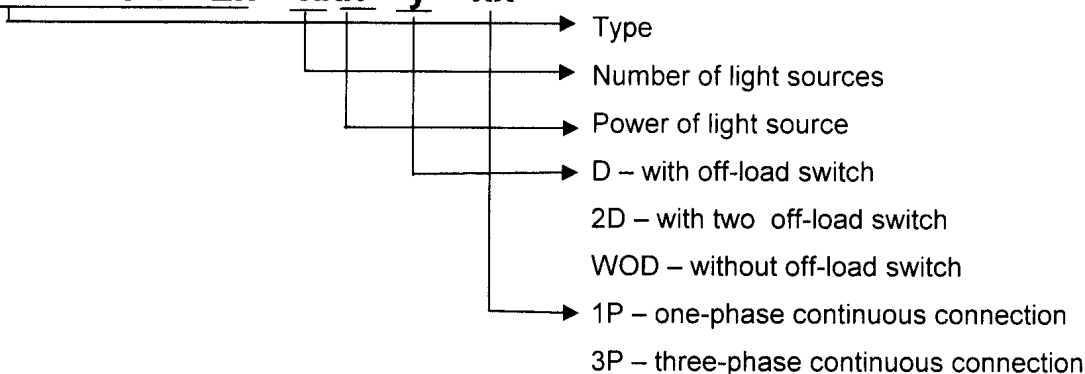

Responsible person:

  
Dipl. Ing. Lukáš Martinák  
Head of certification body

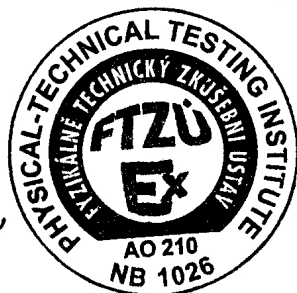

Date of issue: 30.07.2012

Page: 3/3

This supplement to certificate is granted subject to the general conditions of the Physical Technical Testing Institute.  
This supplement to certificate may only be reproduced in its entirety and without any change, schedule included.





Physical Technical Testing Institute  
Ostrava – Radvanice



(1) **Supplement No. 6 to  
EC-Type Examination Certificate**

(2) **Equipment or Protective Systems Intended for Use  
in Potentially Explosive Atmospheres  
(Directive 94/9/EC)**

(3) EC-Type Examination Certificate Number:

**FTZÚ 04 ATEX 0143X**

(4) Equipment or protective system: **Flameproof luminaire type  
PITBUL-Ex, PITBUL -Ex-Em, MULTIPITBUL-Ex**

(5) Manufacturer: **VYRTYCH a.s.**

(6) Address: **Bělehradská 314/18, 140 00 Praha 4, Czech Republic**

(7) This supplement of certificate is valid for: - Modification of certified apparatus.

(8) Modification of certified apparatus (protective system) and any of its approved variants are specified in documentation, a list of which is mentioned in the schedule of this certificate.

(9) This supplement to type examination certificate is valid only for type examination of design and construction of product sample in accordance with Annex 3 Paragraph 6) of Directive No. 94/9/EC. The Directive contains other requirements, which manufacturer shall fulfil before products are placed on the market or introduce in service.

(10) Safety requirements of modified parts were fulfilled by satisfying the following standards:

**EN 60079-0:2009; EN 60079-1:2007; EN 60079-7:2007;  
EN 60079-11:2007; EN 60079-18:2009; EN 60079-31:2009**

(11) Marking of equipment shall contain symbols:

 **II 2G Ex d e ib mb IIC T4 Gb**

 **II 2D Ex tb IIIC Db T 60°C**

(12) This type examination certificate is valid till: **31.07.2017**

Responsible person:

  
Dipl. Ing. Lukáš Martinák  
Head of Certification Body



Date of issue: 12.06.2014

Page: 1/2  
Annex No. 1 (2 pages)

This supplement to certificate is granted subject to the general conditions of the FTZÚ, s.p.  
This supplement to certificate may only be reproduced in its entirety and without any change, schedule included.

FTZÚ, s.p. - Pikartská 1337/7, 716 07 Ostrava-Radvanice, Czech Republic,  
tel +420 595 223 111, fax +420 596 232 672, ftzu@ftzu.cz, www.ftzu.cz



Physical Technical Testing Institute  
Ostrava – Radvanice

(13)

Schedule

(14)

Supplement No. 6 to  
EC-Type Examination Certificate N° FTZÚ 04 ATEX 0143X

(15) Description of Equipment or Protective System:

The equipment modification consists of the alternative using to other types of Ex-cable glands and Ex-blanking elements according to the component list mentioned in Annex.

There on the apparatus are not made any constructional changes in comparison to the certified model.

(16) Report No.: 04/0143-6

dated 11.06.2014

(17) Special conditions for safe use:

17.1 The conditions mentioned in the supplement No. 5 are valid in whole range.

(18) Essential Health and Safety Requirements:

Covered by standards mentioned in (10) of this supplement to certificate.

(19) List of Documentation:

Technical description rev. 08

dated 11.04.2014

11 pages

Responsible person:

  
Dipl. Ing. Lukáš Martinák  
Head of Certification Body



Date of issue: 12.06.2014

Page: 2/2

Annex No. 1 (2 pages)

This supplement to certificate is granted subject to the general conditions of the FTZÚ, s.p.  
This supplement to certificate may only be reproduced in its entirety and without any change, schedule included.



Physical Technical Testing Institute  
Ostrava – Radvanice

**ANNEX No. 1**  
to Supplement No. 6 to  
**EC-Type Examination Certificate N° FTZÚ 04 ATEX 0143X**

List of used components (Cable gland and plug)

Component	Type	Thread	Certificate
cable gland	V-TEC EX	M20x1,5; M25x1,5	PTB 99 ATEX 3112X
cable gland	V-TEC EX	M16x1,5	PTB 99 ATEX 3113X
cable gland	HSK-K...-Ex	M20x1,5; M25x1,5	TÜV 12 1261 X
cable gland	HSK-K...-Ex	M16x1,5	IECEX BVS 11.0064U
cable gland	HSK-K...-Ex, HSK-M...-Ex; HSK-INOX-EMV-PVDF-Ex	M16x1,5; M20x1,5; M25x1,5	IECEX KEM 07.0014X
cable gland	EXIOS;EXIOS MZ	M16x1,5; M20x1,5; M25x1,5	IECEX BVS 10.0078X
blanking elements	V...-Ex-d, RSD	M16x1,5; M20x1,5; M25x1,5	IECEX KEM 07.0012
cable gland	GHG 960 92. P...	M16x1,5; M20x1,5; M25x1,5	IECEX PTB 05.0004X
cable gland	GHG 960. R...	M20x1,5; M25x1,5	IECEX BKI 08.0007
cable gland	ADE-.....	M16; M20; M25	IECEX INE 12.0025X
blanking elements	GHG 960 **** * ****	M16; M20; M25	IECEX PTB 03.0000
blanking elements	CK; CQ	M16; M20; M25	SIRA 10 ATEX 1225X
blanking elements	GHG 960 1927 R....	M25	PTB 01 ATEX 1128X
blanking elements	DP-E	M20;M25	IECEX SIR 08.0024U
cable gland	*SKE/1(S)(-L)-*(-RDE) ** (LT) (**-****)	M16x1,5; M20x1,5; M25x1,5	IECEX PTB 13.0034X
cable gland	**SSKE(S)(-L)(-4)(-RDE) **(-**) (LT) (****)	M16x1,5; M20x1,5; M25x1,5	IECEX PTB 13.0035X
cable gland	**SKEZ(-L)(-**) **(-**) (LT) (****)	M16x1,5; M20x1,5; M25x1,5	IECEX PTB 13.0052X
cable gland	*MSKE(S)(-L)(-**)(-RDE) **(-**) (LT) (****)	M16x1,5; M20x1,5; M25x1,5	IECEX PTB 13.0027X
blanking elements	Ex e	M16x1,5; M20x1,5; M25x1,5	IECEX PTB 10.0003
cable gland	B...X; B...DC-X	M16x1,5; M20x1,5; M25x1,5	IECEX IMQ 13.0003X
cable gland	EBU...; EBM...; EBMC...; EBS...; EBLS...; EBLQ...; EBLN...	M16x1,5; M20x1,5; M25x1,5	IECEX IMQ 13.0006X
cable gland	KBA;KBU	M16x1,5; M20x1,5; M25x1,5	IECEX IMQ 13.0013X
blanking elements	TP-X	M16; M20; M25	IECEX IMQ 13.0003X
blanking elements	B-RA...; B-RB...; B-RM...; B-RN... and B-TS...	M16; M20; M25	IECEX CES 13.0022X

Responsible person:

*Lukáš Martinák*  
Dipl. Ing. Lukáš Martinák  
Head of Certification Body



Date of issue: 12.06.2014

Page: 1/2

This supplement to certificate is granted subject to the general conditions of the FTZÚ, s.p.  
This supplement to certificate may only be reproduced in its entirety and without any change, schedule included.



Physical Technical Testing Institute  
Ostrava – Radvanice

**ANNEX No. 1**  
to Supplement No. 6 to  
EC-Type Examination Certificate N° FTZÚ 04 ATEX 0143X

List of used components (Cable gland and plug)

Component	Type	Thread	Certificate
cable gland	REV, REVD	M16x1,5, M20x1,5, M25x1,5	IECEX CES 13.0011X
cable gland	A8*F, A8C**F, D8X*F, E8X*F	M20x1,5	IECEX SIR 05.0020X
cable gland	E****F*, D****F, C****E*	M20x1,5, M25x1,5	IECEX SIR 07.0097X
cable gland	A****, A*L**, A*LC***, A*RC***	M20x1,5, M25x1,5	IECEX SIR 07.0096X
cable gland	CR-***, CR-D**, CR-O***	M20x1,5, M25x1,5	IECEX SIR 07.0099X
blanking elements	AR, SPA, SPB, SPHH	M16; M20; M25	IECEX SIR 09.0131X
blanking elements	ACDP	M20x1,5, M25x1,5	IECEX SIR 09.0132U
cable gland	501/421; 501/423; 501/453	M16x1,5; M20x1,5; M25x1,5	IECEX BAS 06.0013X
blanking elements	375	M16; M20; M25	IECEX BAS 12.0065X
blanking elements	390	M16; M20; M25	ECEX BAS 11.0079X
blanking elements	387	M16; M20; M25	IECEX BAS 06.0029U

Responsible person:

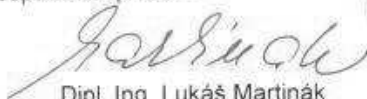
  
Dipl. Ing. Lukáš Martinák  
Head of Certification Body



Date of issue: 12.06.2014

Page: 2/2

This supplement to certificate is granted subject to the general conditions of the FTZÚ, s.p.  
This supplement to certificate may only be reproduced in its entirety and without any change, schedule included.

FTZÚ, s.p., Píkářská 1337/7, 716 07 Ostrava-Radvanice, Czech Republic.  
tel +420 595 223 111, fax +420 596 232 672, ftzu@ftzu.cz, www.ftzu.cz



(1) **Supplementary EU - Type Examination Certificate No.7**

(2) **Equipment or Protective Systems Intended for Use  
in Potentially Explosive Atmospheres  
(Directive 2014/34/EU)**

(3) EU - Type Examination Certificate number:

**FTZÚ 04 ATEX 0143X**

(4) Product: **Flameproof luminaire type PITBUL-Ex, PITBUL-Ex-Em, MULTIPITBUL-Ex**

(5) Manufacturer: **VYRTYCH a.s.**

(6) Address: **Bělehradská 314/18, 140 00 Praha 4, Czech Republic**

(7) This supplementary certificate extends EC - Type Examination Certificate No. FTZÚ 04 ATEX 0143X to apply to products designed and constructed in accordance with the specification set out in the Schedule of the said certificate but having any variations specified in the Schedule attached to this certificate and the documents therein referred to.

(8) The Physical-Technical Testing Institute, Notified Body number 1026, in accordance with Articles 17 of Directive 2014/34/EU of the European Parliament and of the Council, dated 26.02.2014, certifies that this product, as modified by this supplementary certificate, has been found to comply with the Essential Health and Safety Requirements relating to the design and construction of products intended for use in potentially explosive atmospheres given in Annex II to the Directive.

(9) In accordance with Article 41 of Directive 2014/34/EU, EC-Type Examination Certificates referring to 94/9/EC that were in existence prior to the date of application of 2014/34/EU (20.04.2016) may be referenced as if they were issued in accordance with Directive 2014/34/EU. Supplementary Certificates to such EC-Type Examination Certificates, and new issues of such certificates, may continue to bear the original certificate number issued prior to 20.04.2016.

(10) Compliance with the Essential Health and Safety Requirements has been assured by compliance with:

**EN 60079-0:2012, EN 60079-1:2014, EN 60079-7:2015, EN 60079-11:2012,  
EN 6079-18:2015; EN 60079-31:2014**

(11) The marking of the product shall include the following:

 **II 2G Ex db eb ib mb IIC T4 Gb** – see clause (15)

 **II 2D Ex tb IIIC T60°C Db**

(12) This certificate is valid till: **31.08.2021**

Responsible person:

  
Dipl. Ing. Lukáš Martinák  
Head of Certification Body



Date of issue: 30.08.2016

Page: 1/3

This certificate is granted subject to the general conditions of the FTZÚ, s.p.  
This certificate may only be reproduced in its entirety and without any change, schedule included.



**Physical-Technical Testing Institute  
Ostrava - Radvanice**

(13) **Schedule**

(14) **Supplementary EU - Type Examination Certificate No. 7  
to FTZÚ 04 ATEX 0143X**

(15) Description of the variation to the Product:

The subject of this supplementary certificate is:

- Modification of certified apparatus;
- Evaluation according to the new editions of the standards;
- Prolongation of certificate validity.

This supplementary certificate modifies Ex-components used into the luminaire. Alternative Ex-components from producer Jakubiec, Poland were eliminated.

There on the apparatus are not made any constructional changes in comparison to the certified model.

The luminaire is recertified according to standards EN 60079-0:2012; EN 60079-1:2014; EN 60079-7:2015; EN 60079-11:2012; EN 60079-18:2015 and EN 60079-31:2014.

Ex marking of product:

- ⊕ II 2G Ex db eb mb IIC T4 Gb – luminaire with off-load switch;
- ⊕ II 2G Ex db eb ib mb IIC T4 Gb – luminaire with off-load switch and Watchdog unit CG-S module;
- ⊕ II 2G Ex eb mb IIC T4 Gb – luminaire without off-load switch and Watchdog unit CG-S module.

Coding of type PITBUL-Ex:

Type coding	Type
PITBUL – Ex – XYY*-D	A type luminaire with off-load switch
PITBUL – Ex - XYY - WOD	A type luminaire without off-load switch
MULTIPITBUL – Ex - XYY - D	A type luminaire (maintained emergency lighting) with off-load switch
MULTIPITBUL – Ex - XYY- WOD	A type luminaire (maintained emergency lighting) without off-load switch
PITBUL- Ex- Em - LED - XYY	A type luminaire (non-maintained emergency lighting)

\*X - number of light sources 1/2/3/4x

YYY - type marking of light source 18/36/58W – T26

Responsible person:

*Lukáš Martinák*  
Dipl. Ing. Lukáš Martinák  
Head of Certification Body



Date of issue: 30.08.2016

Page: 2/3

This certificate is granted subject to the general conditions of the FTZÚ, s.p.  
This certificate may only be reproduced in its entirety and without any change, schedule included.

Physical-Technical Testing Institute, s.p., Pikartská 1337/7, 716 07 Ostrava - Radvanice, Czech Republic  
tel +420 595 223 111, fax +420 596 232 672, ftzu@ftzu.cz, www.ftzu.cz



Physical-Technical Testing Institute  
Ostrava - Radvanice

(13)

Schedule

(14) **Supplementary EU - Type Examination Certificate No. 7  
to FTZÚ 04 ATEX 0143X**

(16) Report Number.: 04/0143/7

(17) Specific Conditions of Use:

1. The type luminaire without installed off-load switch must be labelled "Do not open when energized!".
2. Ambient temperature  $T_{amb}$ :  
0°C to +40°C - for type PITBUL-Ex-Em and MULTIPITBUL-Ex.
3. The luminaire is intended for fixed installation and must be labelled "Warning - potential danger of electrostatic charging!" – see Technical conditions.
4. The Technical conditions of maintenance must be complied.

(18) Essential Health and Safety Requirements:

Compliance with the Essential Health and Safety Requirements is covered by standards mentioned in clause (10) of this supplementary certificate.

(19) Drawings and Documents:

Number	Sheets	Issue	Date	Description
--	10	10	19.08.2016	Technical description
--	2	01	19.08.2016	Technical conditions
--	6	01	18.08.2016	Drawing of the labels

Responsible person:

  
Dipl. Ing. Lukáš Martinák  
Head of Certification Body



Date of issue: 30.08.2016

Page: 3/3